

MS DENTAL

Soluções Ortodônticas

CATÁLOGO 2024 | www.ms dental.pt



- *Linha de produtos MS*
- *Distalizador Carrière*
- *LM-Activators*
- *Micro implantes Jeil*
- *Promoções permanentes*
- *O que é a MS Academy !?*

MS EMPRESA

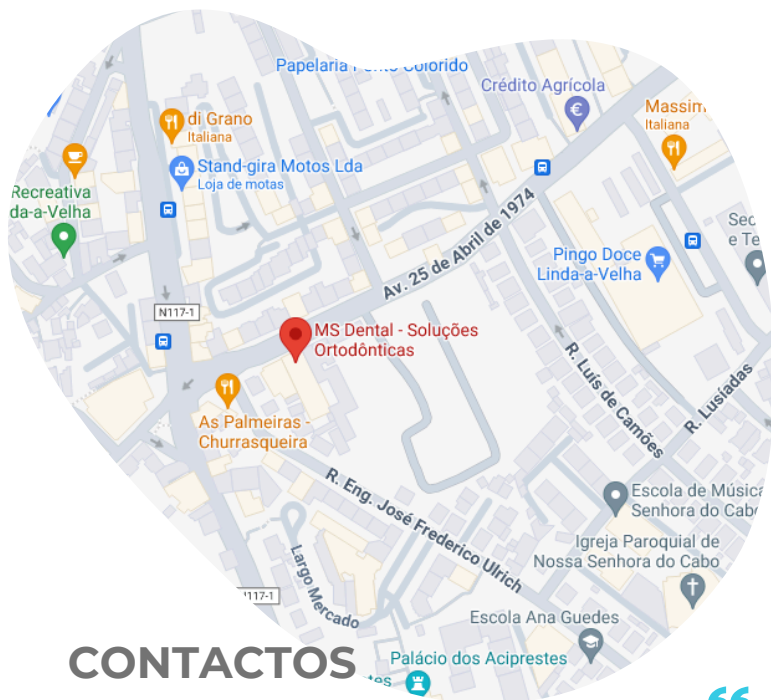

MS DENTAL
Soluções Ortodónticas

CONTACTOS

- ☎ 211 313 888 / 961 447 118 (Zona centro/Sul)
- ☎ 926 668 330 (Zona Norte)
- ✉ geral@msdental.pt
- 🌐 www.msdental.pt
- 📍 Av. 25 de Abril de 1974 n35 - 1D, 2795-144 Linda-a-Velha

TERMOS E CONDIÇÕES

Pagamentos e devoluções

Os pagamentos são efetuados no ato de entrega, ou de outra forma a combinar.
As devoluções deverão ser feitas num prazo de 15 dias, após entrega.
Os produtos devolvidos deverão estar em condições de ser novamente comercializados, excetuando quando o produto não corresponde ao pretendido pelo cliente.

Portes de envio

Encomendas para o Continente de valor inferior a 100.00€, podem estar sujeitas à aplicação de uma taxa, consoante o tamanho e dimensão. Para fora do Continente, valor sob consulta.

Preços

Aos preços apresentados neste catálogo, será acrescentado o valor do IVA à taxa legal em vigor.
Os preços podem sofrer alterações, sem que exista obrigação de comunicação prévia por parte da MS.

“
PROFISSIONALISMO E MODERNIZAÇÃO - COMPRAR CONNOSCO É COMPRAR DIRETAMENTE DA FÁBRICA, A PREÇO REDUZIDO COM EXCELENTE QUALIDADE!
”

MS DENTAL

A **MS Dental**, (MagneticSilver, Lda) inicia a sua atividade em 2011, sendo a primeira empresa em Portugal a criar a sua própria marca, apostando em produtos de excelência e qualidade comprovada. As nossas fábricas, estão pelos 4 cantos do Mundo, EUA, Suíça, Alemanha, Coreia, China e Paquistão

O nosso crescimento, deve-se fundamentalmente ao fato de centrar os seus objetivos, na satisfação dos clientes.

Ao longo da nossa permanência no mercado, temos diligenciado no sentido de retribuir a fidelização dos clientes com a estabilidade de preços e, sempre que possível, na sua redução e focados na qualidade dos produtos.

Privilegiamos o intercâmbio de informações, zelando pelo profissionalismo e modernização.

A vossa confiança e exigência são pressupostos vitais na prossecução dos nossos objetivos.

SER SOLIDÁRIO

Este é mais um ano em que vamos apoiar a ASOT, associação que presta cuidados de saúde oral, junto da população carenciada. Ajude-nos a ajudar.
Saiba como no nosso Site ou contacte diretamente a Associação
Contacto - +351 961 808 485



www.msdental.pt

211 313 888

(Chamada para rede fixa nacional)

5% DESCONTO EM LOJA ONLINE



geral@msdental.pt

Porto - 926 668 330

(Chamada para rede móvel nacional)

Lisboa - 961 447 118

(Chamada para rede móvel nacional)

Margem Sul- 964 988 302

(Chamada para rede móvel nacional)

ÍNDICE

Promoções Permanentes **pág. 4**



Arcos **pág. 5**

Bandas **pág. 6**



Brackets e Tubos **pág. 7**

Brackets Autoligáveis **pág. 8**

Brackets Estéticos **pág. 8**



Acessórios **pág. 9**

Molas, Botões, Ligaduras Metálicas... **pág. 10**



Outros materiais **pág. 11**



Elásticos **pág. 12**
Ligaduras, cadeias, Intra orais... **pág. 13**

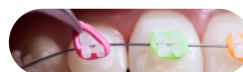

Micro implantes **pág. 14**



Alicates **pág. 15**



Cimento, Cola e Contenção GAMA RELIANCE **pág. 16**



Ortho Organizer Ditalizadores Rotadores **pág. 17**

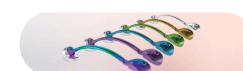

Scanner - 3Disc **pág. 18**



Stripping - Oscident **pág. 19**



Jeil Medical - Microimplantes **pág. 20**
pág. 21



LM-activator **pág. 22**
pág. 23



MS ORTHO ACADEMY **pág. 24**



www.ms dental.pt

211 313 888

(Chamada para rede fixa nacional)

5% DESCONTO EM LOJA ONLINE

 **geral@msdental.pt**

Porto - 926 668 330

(Chamada para rede móvel nacional)

Lisboa - 961 447 118

(Chamada para rede móvel nacional)

Margem Sul- 964 988 302

(Chamada para rede móvel nacional)

PROMOÇÕES PERMANENTES

Na compra de 5 artigos oferta de 1 igual

Campanha não acumulável com outras em vigor



Kit Bracket Convencional
Roth / Mbt / Edgewise

16.00€ x 5 = 80.00€

EX: Oferta 1 caso - 16.00€



Autoligável Shell
Roth / Mbt

95.00€



caso cerâmica
Roth/Mbt

65.00€



Mola Fechada

6mm
9 mm
12mm
Pack 10

19.00€



Arco Aço

Pack 10 Pack 10

5.50€ 8.00€

Redondos Retangulares



Niquel Titânio - Niti
forma ovóide

Pack 10 Pack 10

7.50€ 10.50€

Redondos Retangulares



Arco Termoativado

Pack 10 Pack 10

12.90€ 14.90€

Redondos Retangulares



Mola Aberta

0,010
0,012

15.00€



Pica Línguas

Pack 10

15.00€



Botões Linguais
base retangular

Pack 10

12.00€



Ligaduras

Pack 1020

12.00€



Cadeias

- Closed (continua)
- Short (média)
- Long
- Rolo com 450 cm.

12.00€



www.ms dental.pt

211 313 888

(Chamada para rede fixa nacional)

5% DESCONTO EM LOJA ONLINE



geral@msdental.pt

Porto - 926 668 330

(Chamada para rede móvel nacional)

Lisboa - 961 447 118

(Chamada para rede móvel nacional)

Margem Sul- 964 988 302

(Chamada para rede móvel nacional)

ARCOS



Aço

0,012	0,016 x 0,016
0,014	0,016 x 0,022
0,016	0,017 x 0,022
0,018	0,017 x 0,025
0,020	0,018 x 0,022
	0,018 x 0,025
	0,019 x 0,025
	0,021 x 0,025

Disponível em ovóide e trueform

Pack 10

Pack 10

5.50€ **8.00€**

Redondos

Retangulares



Niquél Titânio - Niti

0,012	0,014 x 0,025
0,014	0,016 x 0,016
0,016	0,016 x 0,022
0,018	0,017 x 0,022
0,020	0,017 x 0,025
	0,018 x 0,022
	0,018 x 0,025
	0,019 x 0,025
	0,021 x 0,025

Disponível em ovóide e trueform

Pack 10

Pack 10

7.50€ **10.50€**

Redondos

Retangulares



Termoativados

0,012	0,014 x 0,025
0,014	0,016 x 0,016
0,016	0,016 x 0,022
0,018	0,017 x 0,022
0,020	0,017 x 0,025
	0,018 x 0,022
	0,018 x 0,025
	0,019 x 0,025
	0,021 x 0,025

Disponível em ovóide e trueform

Pack 10

Pack 10

12.90€ **14.90€**

Redondos

Retangulares



Ovóide



Trueform



Arco Estético Niti

Revestido a branco

0,012	0,016 x 0,016
0,014	0,016 x 0,022
0,016	0,017 x 0,022
0,018	0,017 x 0,025
0,020	0,018 x 0,022
	0,018 x 0,025
	0,019 x 0,025
	0,021 x 0,025

Pack 1

Pack 1

8.00€ **9.00€**

Redondos

Retangulares



Copper Niti

0,012	0,014 x 0,025
0,014	0,016 x 0,016
0,016	0,016 x 0,022
0,018	0,016 x 0,025
0,020	0,017 x 0,017
	0,017 x 0,025
	0,018 x 0,018
	0,018 x 0,025
	0,019 x 0,025
	0,020 x 0,020
	0,021 x 0,025

Pack 10

Pack 10

38.00€ **44.00€**

Redondos

Retangulares



Copper Niti com Stops

0,013	0,014 x 0,025
0,014	0,016 x 0,022
0,016	0,016 x 0,025
0,018	0,017 x 0,025
	0,018 x 0,025
	0,019 x 0,025

Pack 1

Pack 1

4.80€ **5.00€**

Redondos

Retangulares



Curva Reversa

0,012	0,016 x 0,016
0,014	0,016 x 0,022
0,016	0,017 x 0,022
0,018	0,017 x 0,025
0,020	0,018 x 0,022
	0,018 x 0,025
	0,019 x 0,025
	0,021 x 0,025

Pack 2

Pack 2

8.00€ **9.50€**

Redondos

Retangulares



www.ms dental.pt

211 313 888

(Chamada para rede fixa nacional)

5% DESCONTO EM LOJA ONLINE



geral@msdental.pt

Porto - 926 668 330

(Chamada para rede móvel nacional)

Lisboa - 961 447 118

(Chamada para rede móvel nacional)

Margem Sul - 964 988 302

(Chamada para rede móvel nacional)

ARCOS



2 T-Loop

0,016 x 0,022 0,017 x 0,025 0,019 x 0,025

26 mm 36 mm
28 mm 38 mm
30 mm 40 mm
32 mm 42 mm
34 mm

Pack 5

33.50€



4 T-Loop

0,016 x 0,022 0,017 x 0,025 0,019 x 0,025

26 mm 36 mm
28 mm 38 mm
30 mm 40 mm
32 mm 42 mm
34 mm

Pack 5

46.00€



Beta Titanium (TMA)

0,016
0,018

Pack 10

62.00€

0,016 x 0,016
0,016 x 0,022
0,017 x 0,025
0,018 x 0,025
0,019 x 0,025
0,021 x 0,025

Pack 10

69.90€



Arco Aço em barra

0,014
0,016
0,018
0,020

Pack 10

19.00€

0,016 x 0,016
0,016 x 0,022
0,017 x 0,025
0,018 x 0,025
0,019 x 0,025
0,021 x 0,025

Pack 10

21.00€



Ball Post

0,016 x 0,025 0,019 x 0,025

22 mm 34 mm
24 mm 36 mm
26 mm 38 mm
28 mm 40 mm
30 mm 42 mm
32 mm 44 mm

Pack 10

84.00€



Arcos Trançados

3/6/8 fios

Barra
00155
00175
00195
00215

Pack 10

34.50€

Forma Oval
0,016 x 0,016
0,016 x 0,022
0,017 x 0,025
0,019 x 0,025

Pack 10

43.50€

BANDAS

Tabela de conversão



Arco australiano



0,12 regular
0,14 regular
0,16 regular
0,18 regular
0,20 regular

32.00€

MS Produtos Dentários	29	29,5	.	30	30,5	.	31	31,5	32	32,5	.	33	33,5	34	34,5	.	35	35,5	36	36,5	.	37	37,5	38	.	38,5	39	.	39,5	40	40,5	41	41,5	42				
A COMPANY	.	.	1	.	2	3	4	5	6	.	7	8	.	9	10	11	12	13	14	15	16	17	.	18	19	20	21	22	23	24	25	.	26	27,29	30	.		
AMERICAN ORTHO	.	.	2	.	3	4	.	5	6	.	7	8	.	9	10	11,12	13	.	14	15	16	.	17	18	19	20	21	22	23	.	24	25	26	27	.	28,30	32	.
DENTALRUM	.	.	3	4	5	6	.	7	.	8	9	10	11	12	.	13	14	15	16	17	18	.	19	20	21	22	23	24	25	26	27	28	29	30	31	32	.	
GAC	2	4	.	5	.	.	6	.	7	.	8	.	9	10	11,12	.	13	14	15	16	17	18	.	19	20,21	22	.	23	24	26	28	.		
LANCER	.	.	.	2	3	.	4	5	6	7	8	9	.	10	11	12	13	.	14	15,16	17	.	18	19	20	21	22	23	.	24	25	27	.	28	29	30,31	32	.
ORMCO	.	.	.	2	3	.	4	5	6	7	8	9	10	11	.	12	13,14	15	16	.	17	18	.	19	20	21	22	23	.	24	.	27	28	29	30	31	.	
ROCKY MOUNTAIN	3	.	.	3,5	4	.	.	4,5	5	5,5	.	6	.	6,5	7	7,5	8	8,5	9	9,5	.	10	10,5	11	12	13	13,5	14	14,5	15	16	16,5	17	17,5	18	18,5	.	
3M-UNITEX	29	29,5	.	.	30	30,5	.	.	31	31,5	32	32,5	.	33	33,5	34	34,5	.	35	35,5	36	36,5	.	37	37,5	38	.	38,5	39	.	39,5	40	40,5	41	41,5	42		
TP ORTHODONTICS	1	2	3	4	5	6	7,8	9,10	11,12	.	13	14	15,16	17	18	.	19,20	21,22	23,24	25	26	27	28	29	30	31	32	.	.	.	
ORTHO ORGANIZERS	.	1	.	.	2	3	.	.	4	.	5	6	.	7	8	9	.	10	11	12,13	14	.	15	16	18,19	20	21	22	.	23	24	25,26	27,28	30,31	32	.		

Anatómicas - **5.00€**

Simples - **6.00€**

Duplas - **6.50€**

Triplas - **6.80€**



www.ms dental.pt

211 313 888

(Chamada para rede fixa nacional)

5% DESCONTO EM LOJA ONLINE



geral@msdental.pt

Porto - 926 668 330

(Chamada para rede móvel nacional)

Lisboa - 961 447 118

(Chamada para rede móvel nacional)

Margem Sul- 964 988 302

(Chamada para rede móvel nacional)

BRACKETS E TUBOS

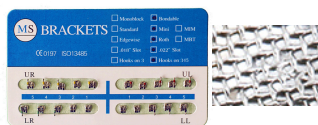

Caso Metálico
16.00€

- Apresenta um baixo perfil com ganchos nos caninos e pré-molares
- Base retentiva (base mesh -80), criando uma maior aderência
- Tamanho Mini e Standard
- Slot 0.18 e 0.22
- Roth / Mbt / Edgewise / Bidimensionais
- Bracket unitários 5.00€ (5unidades)
- Compra 5 casos, oferta 1 caso
- Tabela técnica no final deste catálogo.

50 casos
550.00€
unidade 11.00€



Pack 4 Tubos simples
16/26/36/46

1º molar
Pack 4

10.00€
unidade 2.50€

- Tubos prescrição Roth, Mbt, Edgewise
- Slot 0.22 e 0.18
- Base mesh 80

Cada pack contém
1 tubo de cada quadrante

25 packs
200.00€
unidade 2.00€

Pack 4 Tubos simples
17/27/37/47

2º molar
Pack 4

10.00€
unidade 2.50€



Pack 4 tubos duplos

12.00€

unidade 3.00€

- Tubos prescrição Roth, Mbt, Edgewise
- Slot 0.22 e 0.18
- Base mesh 80
- Prescrição Roth e MBT



Pack 4 tubos triplos

12.00€

unidade 3.00€

Rickets



Caso de brackets
Rickets

24.50€

- Apresenta um baixo perfil com ganchos nos caninos e pré-molares
- Base retentiva (base mesh), criando uma maior aderência
- Tamanho Standard
- Slot 0.18 e 0.22

- Disponível slot 0.18
- Base mesh 80
- Pack 4



Tubos Rickets duplos
Pack 4 tubos

12.50€



www.ms dental.pt

211 313 888

(Chamada para rede fixa nacional)

5% DESCONTO EM LOJA ONLINE



geral@msdental.pt

Porto - 926 668 330

(Chamada para rede móvel nacional)

Lisboa - 961 447 118

(Chamada para rede móvel nacional)

Margem Sul- 964 988 302

(Chamada para rede móvel nacional)

BRACKETS AUTOLIGÁVEIS



Autoligável Shell

Roth / Mbt
Com ganchos no 3, 4, 5
Baixo perfil
Base mesh 80
Autoligável PASSIVO

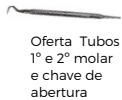

Oferta Tubos
1º e 2º molar
e chave de
abertura

Bracket avulso - 7.00€

95.00€



Autoligável Torque Personalizável

High e low Torque
Standard Torque
Com ganchos 3, 4, 5
Baixo Perfil
Slot 0.22
Autoligável PASSIVO

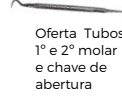

Oferta Tubos
1º e 2º molar
e chave de
abertura

Bracket avulso - 9.00€

145.00€



Tubos para autoligável

ROTH / MBT 0.22
Pack 4 Tubos simples
16/26/36/46

18.20€



Cerâmica Autoligável

Mbt
Fácil abertura
Com ganchos 3, 4, 5
Slot 0.22
Autoligável PASSIVO



Oferta
chave de
abertura

Bracket avulso - 15.00€

235.00€

BRACKETS ESTÉTICOS



Cerâmica

Roth / MBT
Ganchos 3, 4, 5

Bracket avulso - 5.50€

caso **65.00€**



Bracket Estético de Safira Monocristalina BioTech

Roth / Mbt
Baixo perfil;
Não pigmenta
Não retém odores
Resistência muito elevada
Ligaduras elásticas própria

Bracket avulso - 8.00€

caso **99.50€**



Bracket Lingual

Baixo Perfil
Base mesh 80
Gancho 4, 5

caso **99.00€**



Botões cerâmica para tração

Transparente
base redonda
ou retangular

Pack 10

24.00€



Botões cerâmica com gancho

caso

Transparente
base redonda

Pack 10

28.50€



Ligaduras Bio-Tech

- Não pigmentam (30 dias)
- Ultra resistentes
- Pack: 504 elásticos

16.00€



www.ms dental.pt

211 313 888

(Chamada para rede fixa nacional)

5% DESCONTO EM LOJA ONLINE



geral@msdental.pt

Porto - 926 668 330

(Chamada para rede móvel nacional)

Lisboa - 961 447 118

(Chamada para rede móvel nacional)

Margem Sul- 964 988 302

(Chamada para rede móvel nacional)

ACESSÓRIOS



Mola Aberta

0,010
0,012

Pack 2 barras

15.00€



Mola Aberta

0,010
0,012

bobine 91cm

21.50€



Mola Fechada

6mm
9 mm
12mm

Pack 10

19.00€



Mola Fechada

3mm
6mm
9 mm
12mm

Pack 10

19.00€



**Mola
distalizadora**

10-18mm

15.00€



**Molas de
Torque Warren**

0,016 X 0,022
0,017 X 0,025
0,018 X 0,025
0,019 X 0,025

- pequena
- médias
- grande

Pack 10

28.50€



Botões Linguais

Base rectangular

Pack 10

12.00€



Botões Linguais

Base redonda

Pack 10

12.00€



**Botões para tração
com gancho**

Pack 10

14.50€



Botões Eyelet

Base rectangular

Pack 10

19.00€



Botões para tração

Vertical ou lateral

Pack 10

19.00€



**Botões com
buracos na base**

Pack 10

19.00€



www.ms dental.pt

211 313 888

(Chamada para rede fixa nacional)

5% DESCONTO EM LOJA ONLINE

geral@msdental.pt

Porto - 926 668 330

(Chamada para rede móvel nacional)

Lisboa - 961 447 118

(Chamada para rede móvel nacional)

Margem Sul- 964 988 302

(Chamada para rede móvel nacional)

ACESSÓRIOS



Botões com corrente

Prateado Pack 2 Dourado Pack 2

11.00€ 12.00€

NEW!



Double Hooks Lingual

Buttons 9.83mm

Pack 10
19.00€

NEW!



Sliding button

Crimpable hook esquerdo e direito

Pack 10
19.00€



Bite Guide

Pack 10
15.00€



Pica Línguas

Pack 10

15.00€



Ligadura metálica

0.20
0.25
0.30
unidade

15.00€



Ligaduras metálicas Kobayashi

0,012
0,014
100 unidades
Short **29.90€**
Ligadura, cadema, 1000 gram
100 unidades
Long **36.00€**



Ligaduras metálicas Preformadas

0,010
500 unidades
Short **29.90€**
1000 unidades
Long **39.50€**



Ganchos linguais (Crimpable Hooks)

- Pequenos
- Longos

Pack 10

11.00€



Stops

- Redondos
- Rectangulares

Pack 10

10.00€



Máscara Facial com 1 Barra

Disponível em azul e vermelho

39.50€



Máscara Facial com 2 Barras

Disponível em azul e vermelho

51.50€



www.ms dental.pt

211 313 888

(Chamada para rede fixa nacional)

5% DESCONTO EM LOJA ONLINE



geral@msdental.pt

Porto - 926 668 330

(Chamada para rede móvel nacional)

Lisboa - 961 447 118

(Chamada para rede móvel nacional)

Margem Sul - 964 988 302

(Chamada para rede móvel nacional)

OUTROS MATERIAIS



Caixas para retenção

- Pequenas
- Grandes

Pack 12

24.00€

Ceras

Pack 10

11.00€



Chewies

BOLSA COM 2 UNI

1.80€

Removedores

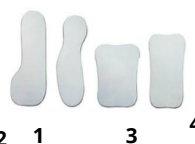
5 UNI

4.99€

Espelhos Fotográficos de dupla face

cada - 30,00€

Pack 4

99.00€

Espelho em aço inoxidável

1 unidade

45.00€

Retrator Bochechas

Pack 2

9.00€

Afastador de Bochechas

1 unidade

9.00€

Retrator de bochechas multi-funções

Transparente e azul
Large/Medium/Small
10.50€

Retrator de lábios

Azul e branco

17.00€

Retrator Bochechas com depressor de língua

Transparente e azul
Large/Medium/Small
10.50€

Retrator Trator ajustável

Azul e verde

35.50€

Capacete

Occipital

1 unidade

29.00€

Capacete

Com mentoneira

1 unidade

52.00€

Tala cervical

1 unidade

8.50€

Tira para tração

1 unidade

4.50€

www.ms dental.pt
211 313 888

(Chamada para rede fixa nacional)

5% DESCONTO EM LOJA ONLINE

geral@msdental.pt
Porto - 926 668 330

(Chamada para rede móvel nacional)

Lisboa - 961 447 118

(Chamada para rede móvel nacional)

Margem Sul- 964 988 302

(Chamada para rede móvel nacional)

ELÁSTICOS

Kit Ortodôntico Higiene



Inclui Bolsa de transporte, passa-fio ortodôntico (12 unidades), espelho pequeno, temporizador, escova normal, escova de viagem, 1 pack ceras e fio dentário.

cada kit
7.00€



Bobine Protetora de Arcos

Cinza ou transparente
3 m
unidade

18.00€



Fio elástico opaco

Transparente

13.50€



Separadores

- Pack: 700 separadores

29.90€



Intra Oraís

- Pack 50 x 100un
- Medidas 1/4 - 1/8 - 3/16 - 5/16
- Força: 2.50oz-3.5oz-4.5oz-6.5oz

39.50€



Cunhas de Rotação

- Cinza ou transparente
- Pack: 100 unidades

19.50€



Posicionador de elásticos

- 100 unidades

28.00€



Cores disponíveis na pág.14

Cadeias

- Closed (continua)
- Short (média)
- Long
- Rolo com 450 cm.

12.00€

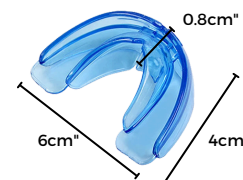

Trainer

19.90€



www.ms dental.pt

211 313 888

(Chamada para rede fixa nacional)

5% DESCONTO EM LOJA ONLINE



geral@msdental.pt

Porto - 926 668 330

(Chamada para rede móvel nacional)

Lisboa - 961 447 118

(Chamada para rede móvel nacional)

Margem Sul- 964 988 302

(Chamada para rede móvel nacional)

ELÁSTICOS

1 Clear	2 Branco	3 Amarelo	4 Rosa	5 Laranja	6 Roxo real
7 Azul claro	8 Verde	9 Cinza	10 Preto	11 Dourado	12 Verde escuro
13 Vermelho escuro	14 Verde mar	15 Azul escuro	16 Roxo	17 Vermelho	18 Bege
19 Laranja vivo	20 Azul marinho				

12.00€ Ligaduras elásticas pack 1040

CADEIAS



12.00€

CADEIA CONTÍNUA



2.8mm

CADEIA MÉDIA



3.5mm

CADEIA LONGA



4.0mm

1 Rosa	2 Branco	3 Amarelo
4 Vinho	5 Azul	6 Preto
7 Verde claro	8 Roxo	9 Verde escuro
10 Cinza	11 Azul bebê	12 Vermelho
13 Transparente		



- Não pigmentam (30 dias)
- Ultra resistentes
- Pack: 504 elásticos

Ligaduras Bio-Tech

16.00€



www.ms dental.pt

211 313 888

(Chamada para rede fixa nacional)

5% DESCONTO EM LOJA ONLINE

geral@msdental.pt

Porto - 926 668 330

(Chamada para rede móvel nacional)

Lisboa - 961 447 118

(Chamada para rede móvel nacional)

Margem Sul- 964 988 302

(Chamada para rede móvel nacional)

MICRO IMPLANTES

MFU Type



medidas	comprimento
1.4 mm	6mm 8mm 10mm
1.6 mm	6mm 8mm 10mm
1.8mm	6mm 8mm 10mm

39.90€/Uni

MFW Type



medidas	comprimento
1.4 mm	6mm 8mm 10mm
1.6 mm	6mm 8mm 10mm

39.90€/uni

Dispositivos de ancoragem temporária tem sido uma das partes mais importantes dos tratamentos, desde o planeamento até o final do tratamento.

Fix Crew pode aliviar o seu stress neste assunto. O Fix crew de correção oferece ancoragem absolutamente fixa e proporciona um tratamento fácil, duradouro e seguro

Feito de titânio reduz significamente as chances de fratura durante o implante. Com sua ponta autoperfurante e roscante, proporciona tratamentos confortáveis para médicos e pacientes.

FIX CREW

Orthodontic screw system

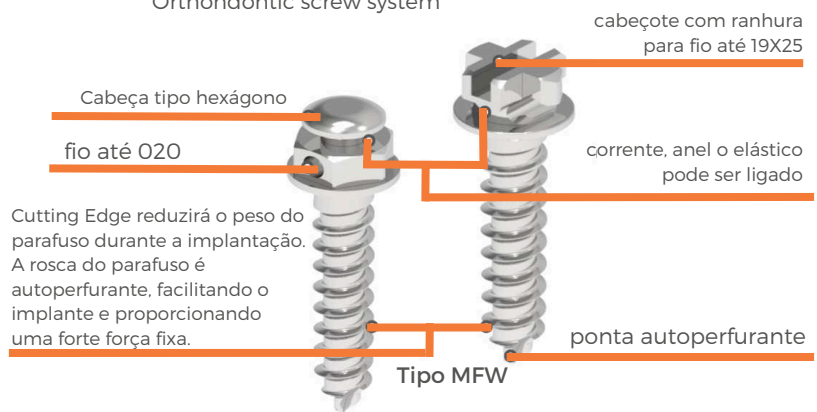

Fix Crew Tray M007	180.00€
Universal Handle M001	105.00€
Universal Handle Shaft M002	61.00€
Hand-piece driver (long) M005	61.00€
Hand-piece driver (short) M004	61.00€
Drill M006	61.00€
Mini Handle M008	61.00€



1020.00€

24 MINI IMPLANTES + Fix Crew Tray, Universal Handle, Universal Handle Shaft, Hand-piece driver (long), Hand-piece driver (short), Drill e Mini Handle



www.ms dental.pt

211 313 888

(Chamada para rede fixa nacional)

5% DESCONTO EM LOJA ONLINE

✉ geral@msdental.pt

Porto - 926 668 330

(Chamada para rede móvel nacional)

Lisboa - 961 447 118

(Chamada para rede móvel nacional)

Margem Sul- 964 988 302

(Chamada para rede móvel nacional)

ALICATES

ALICATES PARA
ALINHADORES

Distal End Cutter

85.00€

Wire Cutter

85.00€

Angle 139

85.00€Ativação Circular
em Alinhador**85.00€**

Brackets Removal

75.00€Distal Bracket
Removal**75.00€**

Band Remover

85.00€Ativação Vertical
em Alinhador**85.00€**

Dobra de NiTi

95.00€

Torque Bender

95.00€

Tweed Combination

95.00€Ativação Horizontal
para Alinhador**85.00€**Pinça Mathiew
ponta fina e ponta média**35.00€**Tesoura Forceps
Mosquito**36.00€**

Medidor brackets

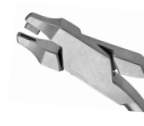
59.00€Corte de Elásticos
para Alinhador**85.00€**

Nance 1

87,50€

Weingart

85.00€

Tridente

95,00€Corte de Botão
para Alinhador**85.00€**Calcador
de Bandas**14.99€**

Pinça Brackets

25.00€Posicionador de
ligaduras duplo**26.00€**Ativação Horizontal
para Alinhador**85.00€**www.ms dental.pt**211 313 888**

(Chamada para rede fixa nacional)

5% DESCONTO EM LOJA ONLINE

geral@msdental.pt**Porto - 926 668 330**

(Chamada para rede móvel nacional)

Lisboa - 961 447 118

(Chamada para rede móvel nacional)

Margem Sul- 964 988 302

(Chamada para rede móvel nacional)

CIMENTO COLA E CONTENÇÃO



RELIANCE

ORTHODONTIC
PRODUCTS



Seringa
Light Bond

- Regular

38.50€



Light Bond
Sealant 3cc

34.00€



Etchant
23g

26.00€

NEW!



Bond aligner

66.00€



Seringa
Ultra Band-Lok

- Azul
- Transparente

36.00€



Kit Seringas
Ultra Band-Lok

180.00€



Seringa
GOTO

49.00€



Pontas de
GOTO

- 11 pontas

45.00€



Bond a Braid

43.50€



Ortho Flextech
Aço Inoxidável

111.50€



Ortho Flextech
Ouro

252.00€



www.ms dental.pt

211 313 888

(Chamada para rede fixa nacional)

5% DESCONTO EM LOJA ONLINE

geral@msdental.pt

Porto - 926 668 330

(Chamada para rede móvel nacional)

Lisboa - 961 447 118

(Chamada para rede móvel nacional)

Margem Sul- 964 988 302

(Chamada para rede móvel nacional)

CLASSE II



1 LADO	PAR
103.00€	184.50€
ESQUERDO	DIREITO

MEDIDA	22mm	
	23 mm	27 mm
	24 mm	28 mm
	25 mm	29 mm
	26 mm	30 mm

CLASSE III



1 LADO	PAR
121.00€	245.00€
ESQUERDO	DIREITO

MEDIDA	16 mm	23 mm
	18 mm	25 mm
	20 mm	27 mm

CARRIERE
Shifting the way you think about orthodontics.

TWIN FORCE
Corrector de Classes II e III



230.50€

TWIN FORCE DOUBLE LOCK
mínimo de 23mm - máximo 32mm
mínimo de 27mm - máximo 36mm

TWIN FORCE ANCHOR WIRE
mínimo de 27mm - máximo 36mm
mínimo de 32mm - máximo 48mm

Elásticos intraorais Carrière



Pack 10 x 100 uni

1/4 - 6oz Força 1	22.50€
3/16 - 8oz Força 2	24.50€

Rotador de molares Niti



MEDIDAS

26mm	36 mm
28mm	38mm
30mm	40mm
32mm	42mm
34mm	44mm

48.20€

Expansor Palatino Niti



MEDIDAS

26mm	36 mm
28mm	38mm
30mm	40mm
32mm	42mm
34mm	44mm

62.00€



www.ms dental.pt

211 313 888

(Chamada para rede fixa nacional)

5% DESCONTO EM LOJA ONLINE

 **geral@msdental.pt**

Porto - 926 668 330

(Chamada para rede móvel nacional)

Lisboa - 961 447 118

(Chamada para rede móvel nacional)

Margem Sul- 964 988 302

(Chamada para rede móvel nacional)

3DISC

Heron™ IOS

THE BEAUTY OF SIMPLICITY

Compactness, ergonomics and lightness are key features for me and for my patients' comfort.

3DISC's proven innovative technology, enhanced by its ergonomic and lightweight scanner, provides stability during the scanning sequence, allowing for constant precision results. Its 20mm scan depth will help you tackle low ridges and other more complicated scan areas.

Dr M. Nawwar BDS, ABOMS

250times 360°

autoclavable tipsrotation

With its 250-times autoclavable tips, 3DISC shows the quality of the material used in our scanner.



Scan Depth
20 mm

150
smallest and lightest

59 sec
for a full arch scan

OFERTA DE IPAD



8.750€

Heron IOS Scanner Specifications

Scanner Type	Hand-held (chairside) scanner that creates optical impressions for dental restorations.
Design	Compact, lightweight, ergonomic - designed to be operated with little physical effort.
Dimensions Base	Size: L 306mm, W 98mm, H 72mm
Dimensions Scanner	Weight: 150 grams
	Size: L 256mm, W 43mm, H 43mm

	Cable length (scanner to base): 2m
Power Requirement	DC 5.0V / 4A (Power supply included)
Scanner Tip	Reusable up to 250 times, sterilize using steam autoclave
Heating Element	Ventilated. Prevents formation of fog on optics
Acquisition Method/Imaging technology	Hybrid technology: active stereo imaging and structured light
Sensor technology	CMOS
Color Scanning	24-bit (8-bit per channel)
Scanning frequency	25-30 FPS
Imaging field-of-view	12mm x 14mm
Light sources	High-power LEDs



OVO IOS Scanner Specifications

Scanner Type	Hand-held (chairside) scanner that creates optical impressions for dental restorations.
Design	Compact, lightweight, ergonomic - designed to be operated with little physical effort.
Dimensions Base	Size: L 154mm, W 88mm, H 64mm
Dimensions Scanner	Weight: 165 grams
	Size: L 257mm, W 45mm, H 62mm
	Cable length (scanner to base): 2m
Power Requirement	DC 5.0V / 4A (Power supply included)
Scanner Tip	Reusable up to 250 times, sterilize using steam autoclave 
Heating Element	Ventilated. Prevents formation of fog on optics
Acquisition Method/Imaging technology	Hybrid technology: active stereo imaging and structured light
Sensor technology	CMOS
Color Scanning	24-bit (8-bit per channel)
Scanning frequency	25-30 FPS
Imaging field-of-view	12mm x 14mm
Light sources	High-power LEDs

11.250€



www.ms dental.pt

211 313 888

(Chamada para rede fixa nacional)

5% DESCONTO EM LOJA ONLINE



geral@msdental.pt

Porto - 926 668 330

(Chamada para rede móvel nacional)

Lisboa - 961 447 118

(Chamada para rede móvel nacional)

Margem Sul- 964 988 302

(Chamada para rede móvel nacional)



Strips

direita 0.15/0.2/0.25/0.3 ...
 esquerda 0.15/0.2/0.25/0.3 ...
 duplo 0.15/0.2/0.25/0.3/0.4/0.5 ...

39.00€



Polisher

duplo 0.1mm

39.00€



Opener

duplo 1.5mm
 duplo 4.0mm

42.30€



Measuring gauge (5)

59.00€



Starter Set Strips

amarelo-branco-
 vermelho-castanho-
 azul-laranja (strip)

265.00€



Handle double straight and 45° angled

85.00€



Stripholder

149.00€



Lixas de Stripping

12 unidades
 1 lado **20.00€**
 12 unidades
 2 lados **23.00€**

Product (*approximately thickness of Strip)	Article No	Picture	Description		Specials	
"Polisher" 0.1mm"	1015 D		Polisher	yellow	15	extra fine
"Polisher"	1015 L		Polisher	yellow	15	extra fine
"Polisher"	1015 R		Polisher	yellow	15	extra fine
"Strips" 0.15mm"	1025 D			white	25	fine
"Strips"	1025 L			white	25	fine
"Strips"	1025 R			white	25	fine
"Strips" 0.2mm"	1040 D			red	40	medium
"Strips"	1040 L			red	40	medium
"Strips"	1040 R			red	40	medium
"Strips" 0.25mm"	1080 D			grey	60	coarse
"Strips"	1080 L			grey	60	coarse
"Strips"	1080 R			grey	60	coarse
"Strips" 0.3mm"	1090 D			green	90	extra coarse
"Strips"	1090 L			green	90	extra coarse
"Strips"	1090 R			green	90	extra coarse
"Strip" 0.4mm"	1145 D			blue	40	medium
"Strip" 0.5mm"	1150 D			black	90	extra coarse
"Opener"	1115 D		Opener/ Separierenwith teethsaw blade	orange	15	extra fine
"Opener"	1140 D		Opener/ Separierenwith teethsaw blade	red	40	medium



Contra angle hand piece -Sirona-

C/ SPRAY **899.00€**
 C/SPRAY E LUZ **954.00€**



Contra angle hand piece -W&H-

C/ SPRAY **689.55€**
 C/SPRAY E LUZ **693.35€**



www.msidental.pt

211 313 888

(Chamada para rede fixa nacional)

5% DESCONTO EM LOJA ONLINE



geral@msidental.pt

Porto - 926 668 330

(Chamada para rede móvel nacional)

Lisboa - 961 447 118

(Chamada para rede móvel nacional)

Margem Sul- 964 988 302

(Chamada para rede móvel nacional)



Modelo JA

Uso em áreas anteriores, laterais e distais.

A medida de 1,3 mm é ideal para colocação interradicular.

Cabeça fechada para maior higiene. Com ilhó.

68€/u.



Modelo G2

Modelo mais versátil.

Use em áreas anteriores, laterais e distais.

Cabeça aberta para uso com fios auxiliares. Com ilhó.

68€/u.



Modelo JS

Utilização na zona distal, ramo retromolar e zona lingual. com colo transmucoso polido que permite a preservação dos tecidos moles sem perder a ancoragem.

Ilhó opcional.

68€/u.



Modelo JB

Uso em áreas laterais e distais.

Cabeça de botão ideal para uso com molas.

Ilhó opcional

68€/u.



Modelo JD

Uso em áreas anteriores, laterais e distais.











Cabeça tipo suporte com slot 022x.028.

Sem ilhó.

68€/u.

Imagem

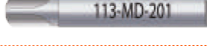
Micro. Aplicáveis

	Imagem	ref.	Micro. Aplicáveis					
			JA	JB	G2	JD	JS	
pontas chave manual	Chave Manual	 ref. 113-MJ-103	✓		✓	✓	✓	
		 ref. 113-JB-101		✓				
		 ref. 113-MD-101	✓		✓		✓	
		 ref. 113-GD-101			✓			
		 ref. 113-NF-101						
	para contra-ângulo	 ref. 113-MJ-203		✓		✓	✓	✓
		 ref. 113-MJ-204				✓	✓	
		 ref. 113-JB-201			✓			
		 ref. 113-MD-201		✓		✓		
		 ref. 113-NF-201						
Broca	 ref. 112-MC-201		✓	✓	✓	✓	✓	

105.98€/u.



www.ms dental.pt

211 313 888

(Chamada para rede fixa nacional)

5% DESCONTO EM LOJA ONLINE



geral@msdental.pt

Porto - 926 668 330

(Chamada para rede móvel nacional)

Lisboa - 961 447 118

(Chamada para rede móvel nacional)

Margem Sul- 964 988 302

(Chamada para rede móvel nacional)

Caixa de contêiner dual-top



305€/u.

Finger Driver Mango chave manual mini

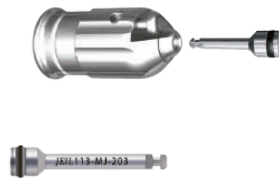

*adaptadores não incluídos
214€/u.

Mango chave manual



*adaptadores não incluídos
158€/u.

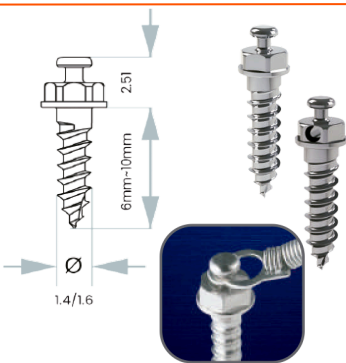

*sem ilhó		
14-JB-006	1.4mm	8mm
14-JB-008	1.4mm	6mm

*com ilhó		
16-JB-006H	1.6mm	6mm
16-JB-008H	1.6mm	8mm
16-JB-010H	1.6mm	10mm

Referência	Diâmetro	Longitude
16-JD-006	1.6mm	6mm
16-JD-008	1.6mm	8mm
16-JD-010	1.6mm	10mm
20-JD-010	2.0mm	10mm

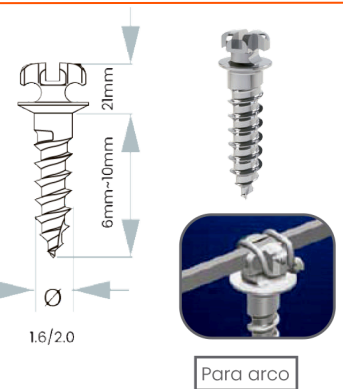

Referência	Diâmetro	Longitude
13-JA-006H	1.3mm	6mm
13-JH-008H	1.3mm	8mm
14-JA-006H	1.4mm	6mm
14-JA-008H	1.4mm	8mm
16-JA-006H	1.6mm	6mm
16-JA-008H	1.6mm	8mm
16-JA-010H	1.6mm	10mm
16-JA-012H	1.6mm	12mm
20-JA-006H	2.0mm	6mm
20-JA-008H	2.0mm	8mm
20-JA-010H	2.0mm	10mm
20-JA-012H	2.0mm	12mm

Modelo JA

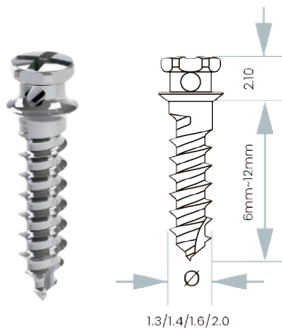

Referência	Diâmetro	Longitude
14-G2-006	1.4mm	6mm
14-G2-008	1.4mm	8mm
16-G2-006	1.6mm	6mm
16-G2-008	1.6mm	8mm
16-G2-010	1.6mm	10mm
16-G2-012	1.6mm	12mm
20-G2-008	2.0mm	8mm
20-G2-010	2.0mm	10mm
20-G2-012	2.0mm	12mm

Modelo G2

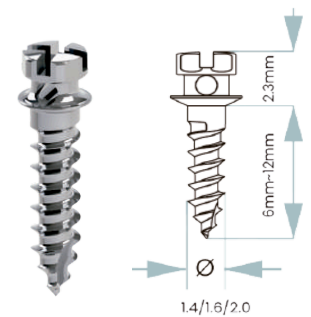

Modelo JS Ideal zona palatina

Referência	Diâmetro	Longitude
20-JS-010	2.0mm	10mm
20-JS-012	2.0mm	12mm
20-JS-014	2.0mm	14mm
20-JS-010H	2.0mm	10mm
20-JS-012H	2.0mm	12mm
20-JS-014H	2.0mm	14mm

Referência	Diâmetro	Longitude
25-JS-014	2.5mm	14mm
205-JS-016	2.5mm	16mm

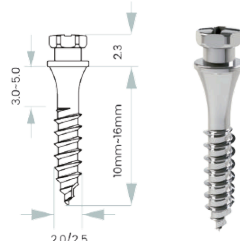

Kit de introdução dual top:

10 microparafusos para escolher
(*Para modelos JD e JS consultar preços)
Caixa recipiente para microparafusos (ref. 112-148)
Cabo de chave de fenda manual sem ponta (ref. 111-010)
Ponta de chave de fenda longa (a eleger)
Micromoinho (ref. 112-MC-201)



1162€/u.



LM-ACTIVATOR™

LM

feel the difference

LM-Activator™ é um ativador e alinhador anatomicamente projetado para tratamento ortodôntico. Ele alinha os dentes e ativa o crescimento mandibular (ou seja, traz a mandíbula para frente para a correção da Classe II) e pode simultaneamente aumentar o comprimento do arco dentário para corrigir ou evitar o apinhamento. O LM-Activator™ suporta o crescimento saudável dos dentes e maxilares de uma forma suave.

LM-Dental™, fundada em 1973, desenvolve, produz e comercializa instrumentos manuais odontológicos de alta tecnologia, aparelhos ortodônticos e muito mais. Com design de produto inovador e tecnologia de produção de alta tecnologia, são o fabricante de instrumentos manuais de crescimento mais rápido na Europa, líder de mercado em todos os países nórdicos e mais de 80% dos produtos são exportados globalmente.



SHORT

Modelo com secção molar mais curta para pacientes cujos segundos molares ainda não irromperam.

LONG

Modelo com secção molar mais longa para pacientes cujos segundos molares irromperam.

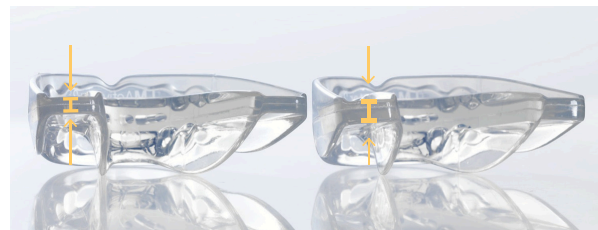

LOW

O modelo com espessura básica do aparelho é aplicável a muitos casos diferentes.

HIGH

Modelo com área pré-molar e molar mais espessa. Projetado especificamente para tratar casos de mordida aberta esquelética e dentoalveolar.



Existem duas larguras de arco diferentes de todos os modelos básicos.

NARROW

Modelo para largura de arcada dentária estreita e regular.

WIDE

Modelo para ampla largura do arco dentário.



Todos os modelos estão disponíveis também com reforço incisal.

REINFORCED

Este modelo possui um reforço rígido de material mais duro na área incisal e é projetado especialmente para casos de mordida profunda esquelética. O modelo também é adequado para outros pacientes beneficiando de uma superfície firme e maior durabilidade.

LM-Trainer™

O LM-Trainer™ pode ser usado na dentição primária, por exemplo, antes do tratamento com LM-Activator™. Também pode ser usado na educação funcional e para correção de hábitos, por exemplo, deglutição reversa e respiração bucal ou quando hábitos orais nocivos correm o risco de causar más oclusões.



45.95€

LM-Trainer™ Medium



45.95€

LM-Trainer™ Small



45.95€

LM-Trainer™ Aparelho



45.95€

LM-TRAINER 2

Curso LM-Dental na página 24



www.ms dental.pt

211 313 888

(Chamada para rede fixa nacional)

5% DESCONTO EM LOJA ONLINE



geral@msdental.pt

Porto - 926 668 330

(Chamada para rede móvel nacional)

Lisboa - 961 447 118

(Chamada para rede móvel nacional)

Margem Sul- 964 988 302

(Chamada para rede móvel nacional)



LM-ACTIVATOR™

O LM-Activator™ tem sido usado por centenas de milhares de pacientes em todo o mundo para corrigir más oclusões e guiar os dentes e a mandíbula para um crescimento saudável.

LM-Activator™ Low Short

Modelo LOW SHORT com secção molar mais curta para pacientes cujos segundos molares ainda não irromperam. Entregue em caixa amarela.

Size	Narrow
10	94010LS
15	94015LS
20	94020LS
25	94025LS
30	94030LS
35	94035LS
40	94040LS
45	94045LS
50	94050LS
55	94055LS
60	94060LS
65	94065LS
70	94070LS



66.00€

LM-Activator™ High Short

Modelo com secção molar mais curta para pacientes cujos segundos molares ainda não irromperam. O modelo HIGH SHORT é mais espesso na região dos segundos pré-molares e molares. É projetado especificamente para o tratamento de casos de mordida aberta esquelética e dentoalveolar. Entregue em caixa laranja.

Size	Narrow
20	94020HS
25	94025HS
30	94030HS
35	94035HS
40	94040HS
45	94045HS
50	94050HS
55	94055HS
60	94060HS
65	94065HS
70	94070HS



66.00€

LM-Activator™ Low Long

Modelo LOW LONG com secção molar mais longa para pacientes cujos segundos molares irromperam. Entregue em caixa azul.

Size	Narrow
40	94040L
45	94045L
50	94050L
55	94055L
60	94060L
65	94065L
70	94070L



66.00€

LM-Activator™ High Long

Modelo com secção molar mais longa para pacientes cujos segundos molares irromperam. O modelo HIGH LONG é mais espesso na região dos segundos pré-molares e molares. É projetado especificamente para o tratamento de casos de mordida aberta esquelética e dentoalveolar. Entregue em caixa verde.

Size	Narrow
45	94045H
50	94050H
55	94055H
60	94060H
65	94065H
70	94070H



66.00€

PREÇO DE LANÇAMENTO: aos 63.50€, será aplicado um desconto de 15% até 30/06/2025 Assim poderá testar a eficácia do nosso aparelho!!!

LM-ACTIVATOR 2™

Modelos para forma de arco largo e/ou com área incisiva reforçada NEW GENERATION

LM-Activator™ 2 Low Short

Modelo com secção molar mais curta para pacientes cujos segundos molares ainda não irromperam. Entregue em caixa amarela.

Size	Narrow	Reinforced	Wide	Reinforced
35	94235LSN	94235LSNR	94235LSW	94235LSWR
40	94240LSN	94240LSNR	94240LSW	94240LSWR
45	94245LSN	94245LSNR	94245LSW	94245LSWR
50	94250LSN	94250LSNR	94250LSW	94250LSWR
55	94255LSN	94255LSNR	94255LSW	94255LSWR
60	94260LSN	94260LSNR	94260LSW	94260LSWR
65	94265LSN	94265LSNR	94265LSW	94265LSWR
70	94270LSN	94270LSNR	94270LSW	94270LSWR



66.00€ Narrow
81.50€ Reinforced

LM-Activator™ 2 High Short

Modelo com secção molar mais curta para pacientes cujos segundos molares ainda não irromperam. O modelo High é mais espesso na região dos segundos pré-molares e molares. É projetado especificamente para o tratamento de casos de mordida aberta esquelética e dentoalveolar. Entregue em caixa laranja.

Size	Narrow	Reinforced	Wide	Reinforced
35	94235HSN	94235HSNR	94235HSW	94235HSWR
40	94240HSN	94240HSNR	94240HSW	94240HSWR
45	94245HSN	94245HSNR	94245HSW	94245HSWR
50	94250HSN	94250HSNR	94250HSW	94250HSWR
55	94255HSN	94255HSNR	94255HSW	94255HSWR
60	94260HSN	94260HSNR	94260HSW	94260HSWR
65	94265HSN	94265HSNR	94265HSW	94265HSWR
70	94270HSN	94270HSNR	94270HSW	94270HSWR



66.00€ Narrow
81.50€ Reinforced

LM-Activator™ 2 Low Long

Modelo com secção molar mais longa para pacientes cujos segundos molares irromperam. Entregue em caixa azul.

Size	Narrow	Reinforced	Wide	Reinforced
35	94235LLN	94235LLNR	94235LLW	94235LLWR
40	94240LLN	94240LLNR	94240LLW	94240LLWR
45	94245LLN	94245LLNR	94245LLW	94245LLWR
50	94250LLN	94250LLNR	94250LLW	94250LLWR
55	94255LLN	94255LLNR	94255LLW	94255LLWR
60	94260LLN	94260LLNR	94260LLW	94260LLWR
65	94265LLN	94265LLNR	94265LLW	94265LLWR
70	94270LLN	94270LLNR	94270LLW	94270LLWR



66.00€ Narrow
81.50€ Reinforced

LM-Activator™ 2 High Long

Modelo com secção molar mais longa para pacientes cujos segundos molares irromperam. O modelo High Long é mais espesso na região dos segundos pré-molares e molares. É projetado especificamente para o tratamento de casos de mordida aberta esquelética e dentoalveolar. Entregue em caixa verde.

Size	Narrow	Reinforced	Wide	Reinforced
35	94235HLN	94235HLNR	94235HLW	94235HLWR
40	94240HLN	94240HLNR	94240HLW	94240HLWR
45	94245HLN	94245HLNR	94245HLW	94245HLWR
50	94250HLN	94250HLNR	94250HLW	94250HLWR
55	94255HLN	94255HLNR	94255HLW	94255HLWR
60	94260HLN	94260HLNR	94260HLW	94260HLWR
65	94265HLN	94265HLNR	94265HLW	94265HLWR
70	94270HLN	94270HLNR	94270HLW	94270HLWR



66.00€ Narrow
81.50€ Reinforced



LM 9400 LM-OrthoSizer™

39.50€



LM 9402 LM-Activator™ 2 OrthoSizer™

39.50€

LM-OrthoSizer™

LM-OrthoSizer™ é uma ferramenta para auxiliar na seleção do tamanho apropriado do LM-Activator™. O tamanho é indicativo e o LM-Activator™ deve sempre ser colocado para garantir o tamanho correto.



www.ms dental.pt

211 313 888

(Chamada para rede fixa nacional)

5% DESCONTO EM LOJA ONLINE



geral@msdental.pt

Porto - 926 668 330

(Chamada para rede móvel nacional)

Lisboa - 961 447 118

(Chamada para rede móvel nacional)

Margem Sul- 964 988 302

(Chamada para rede móvel nacional)

MS ORTHO ACADEMY



A MS Ortho Academy foi criada pela necessidade de acreditação por parte das marcas de alinhadores e aparelhos mio-funcionais, oferecendo cursos detalhados de ortodontia interceptiva e alinhadores transparentes, com formações gratuitas ou pagas, tanto presenciais como online.

No ano de 2024, teremos várias formações de ortodontia interceptiva com LM-activators. Os cursos serão em duas fases, para iniciados e avançados, começando com noções de tratamento interceptativo precoce; o que é LM-Ativador e como funciona; vantagens para o médico e pacientes; indicações de quando e como usar o LM-Activator, no tratamento de más oclusões, Classe II, overjet, etc... apresentando casos de pacientes. Como escolher o aparelho correto. Discussão com perguntas e respostas.

CATÁLOGO 2024 | www.ms dental.pt

Avenida 25 de Abril de 1974, n.º35, 1.º D
2799-506 Linda-a-Velha, Oeiras
Tel: 211 313 888 / 961 447 118
geral@msdental.pt